

burda Download-Schnitt

Modell 008 Easy Fashion E005

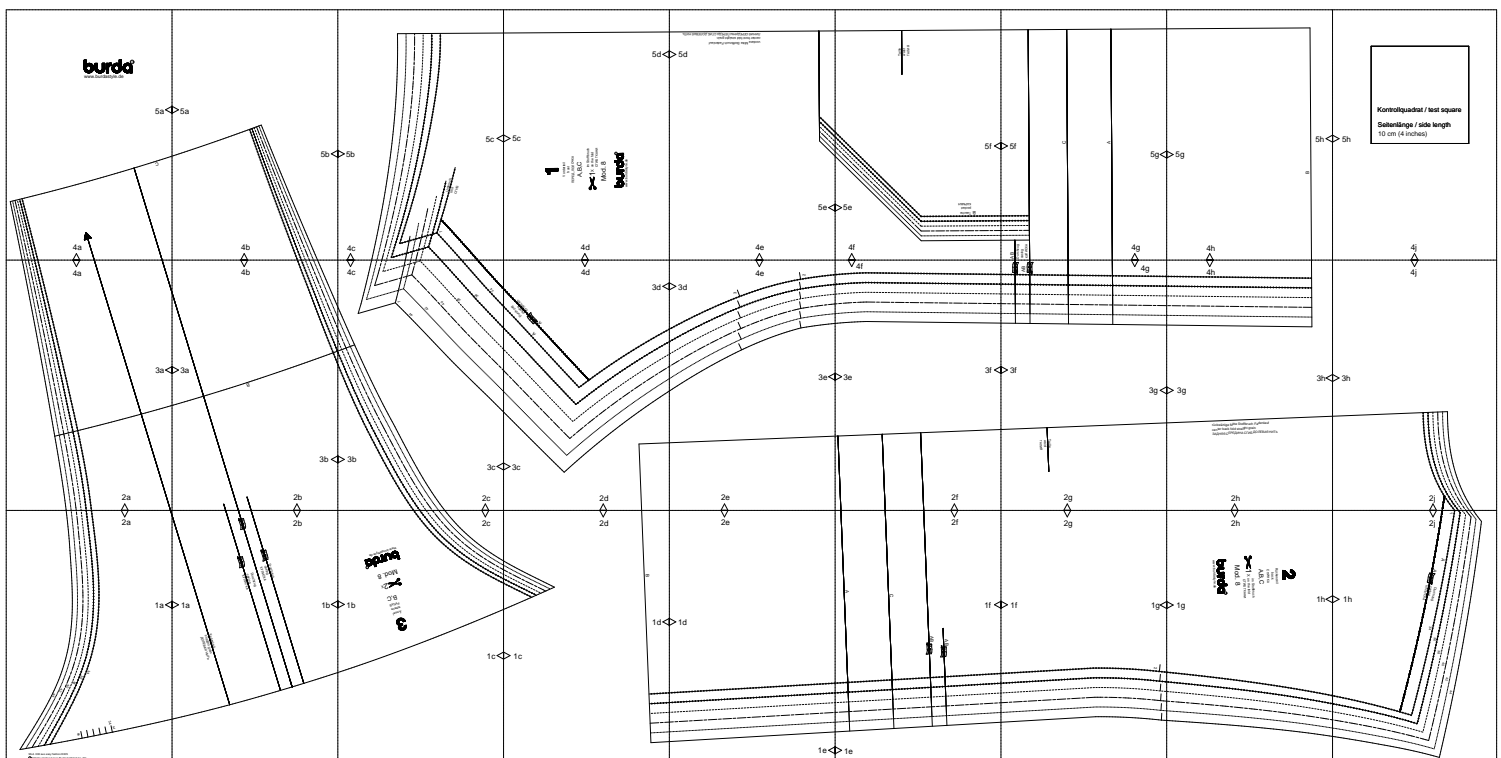

Copyright 2010 by Verlag Aenne Burda GmbH & Co. KG, Am Kestendamm 1, D-77652 Offenburg

Sämtliche Modelle, Schnittteile und Zeichnungen stehen unter Urnehmerschutz, gewerbliches Nacharbeiten ist untersagt.

Der Verlag haftet nicht für Schäden, die durch unsachgemäße Handhabung des Schnitts, der Materialien, unsachgemäße Ausführung der Tipps und Anleitungen oder unsachgemäße Nutzung der Modelle entstehen.

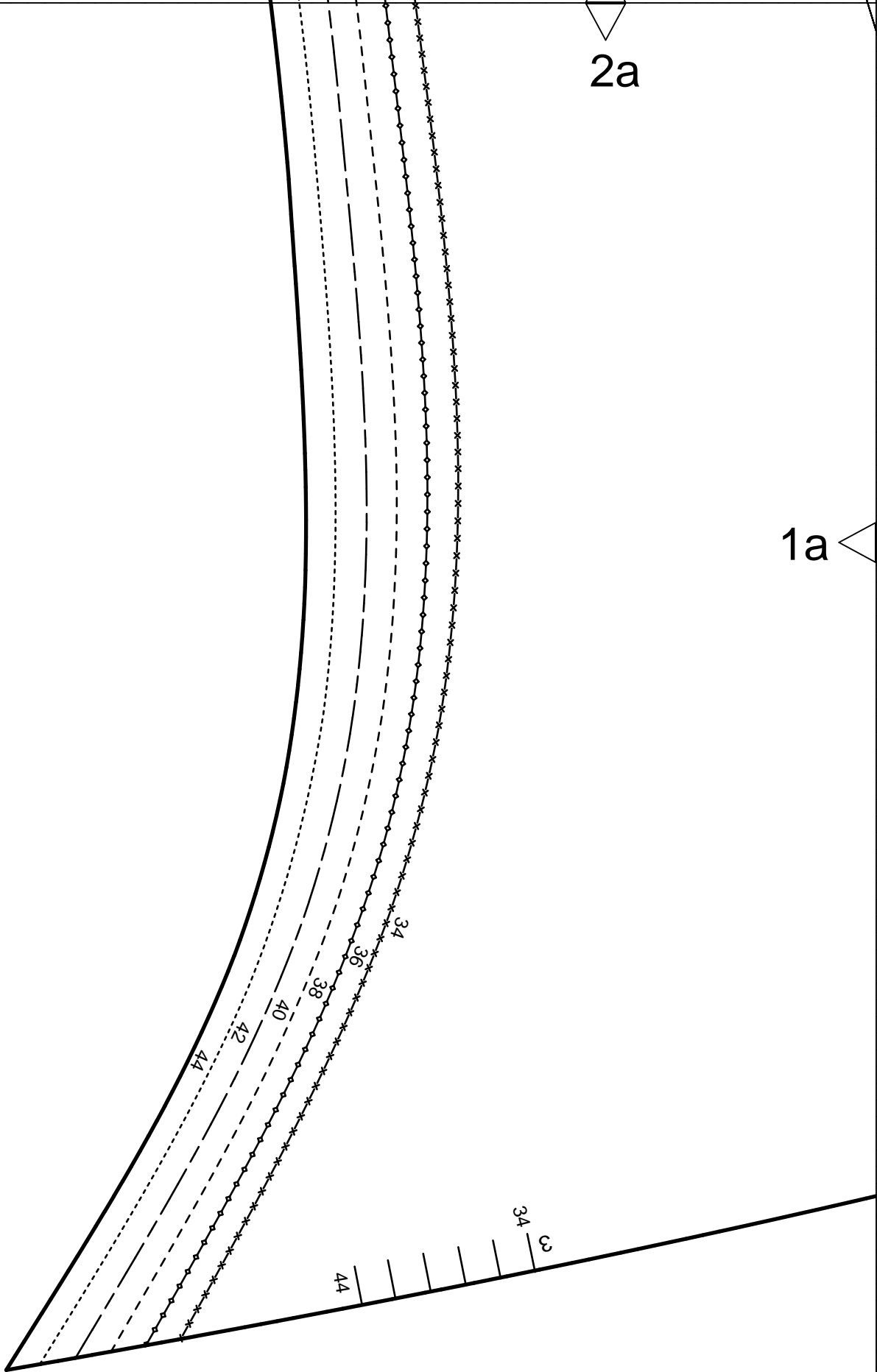

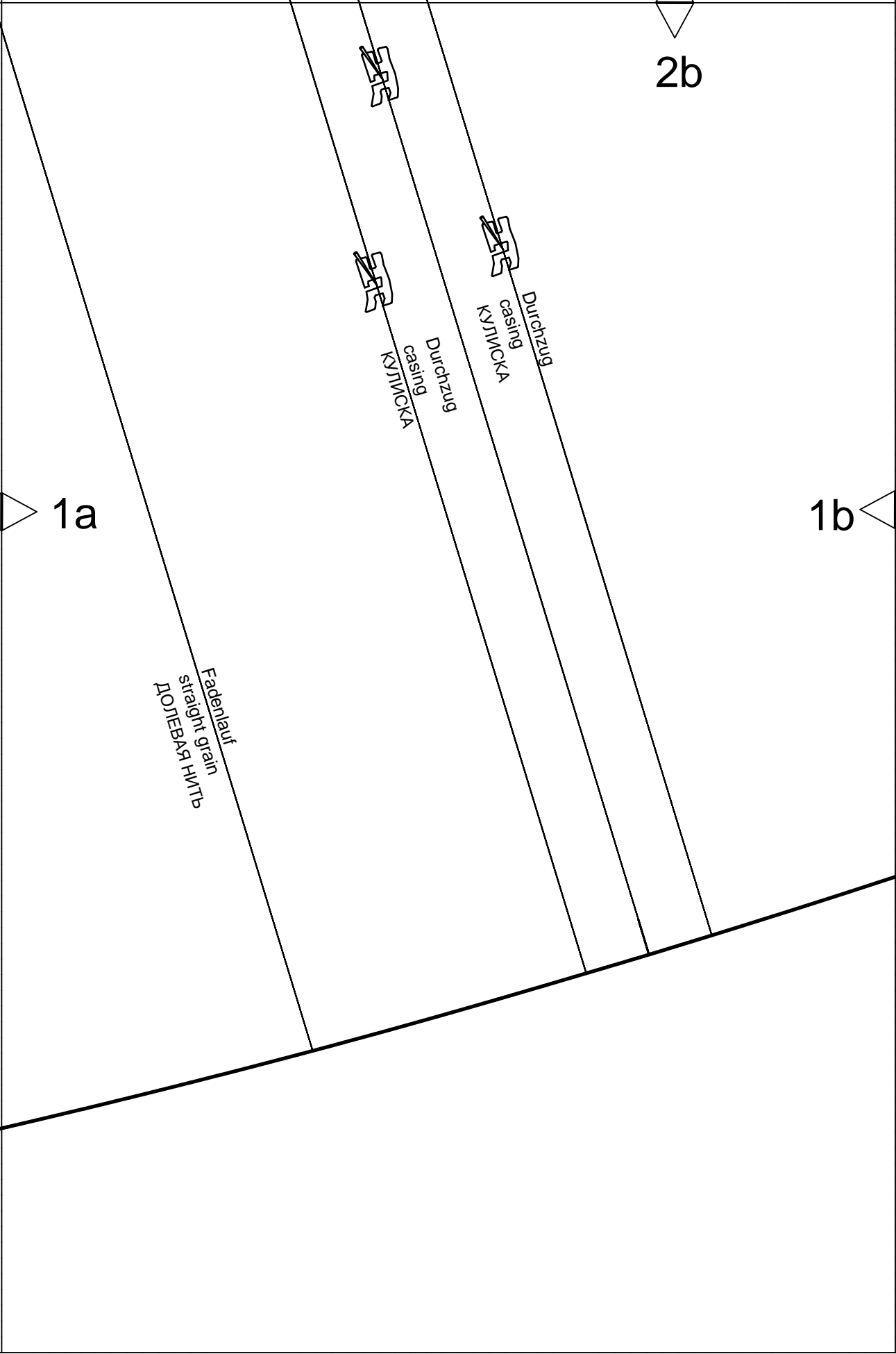

1a

1b

2b

Fadenhaft
straight grain
Долгеевский тип



Durchzug
casing
КЛМЦКА

Durchzug
casing
КЛМЦКА

burda
®
www.burdastyle.de

Mod. 8



Ärmel
sleeve
PYKAB
B,C

3

1b

1c

2c

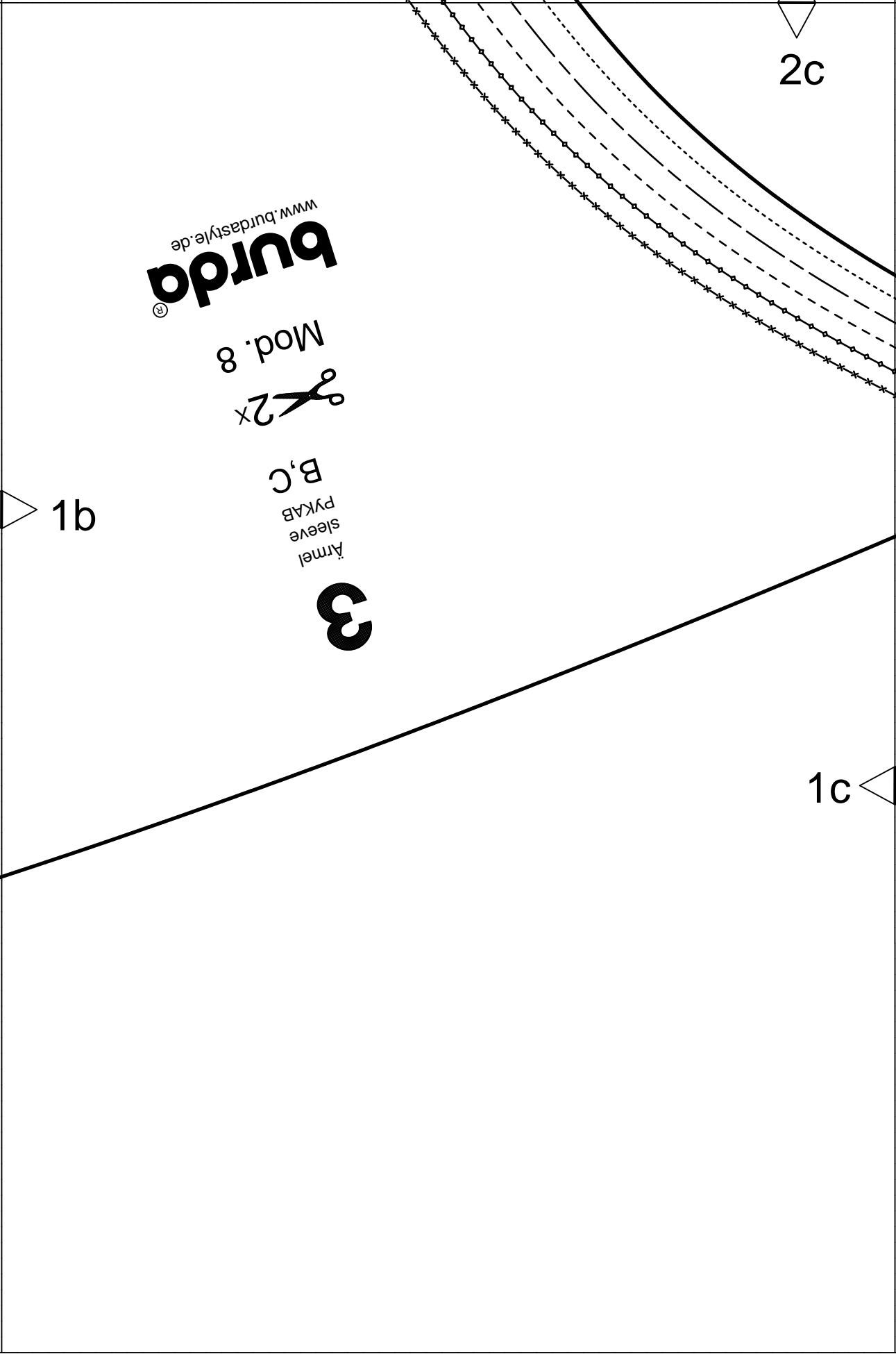

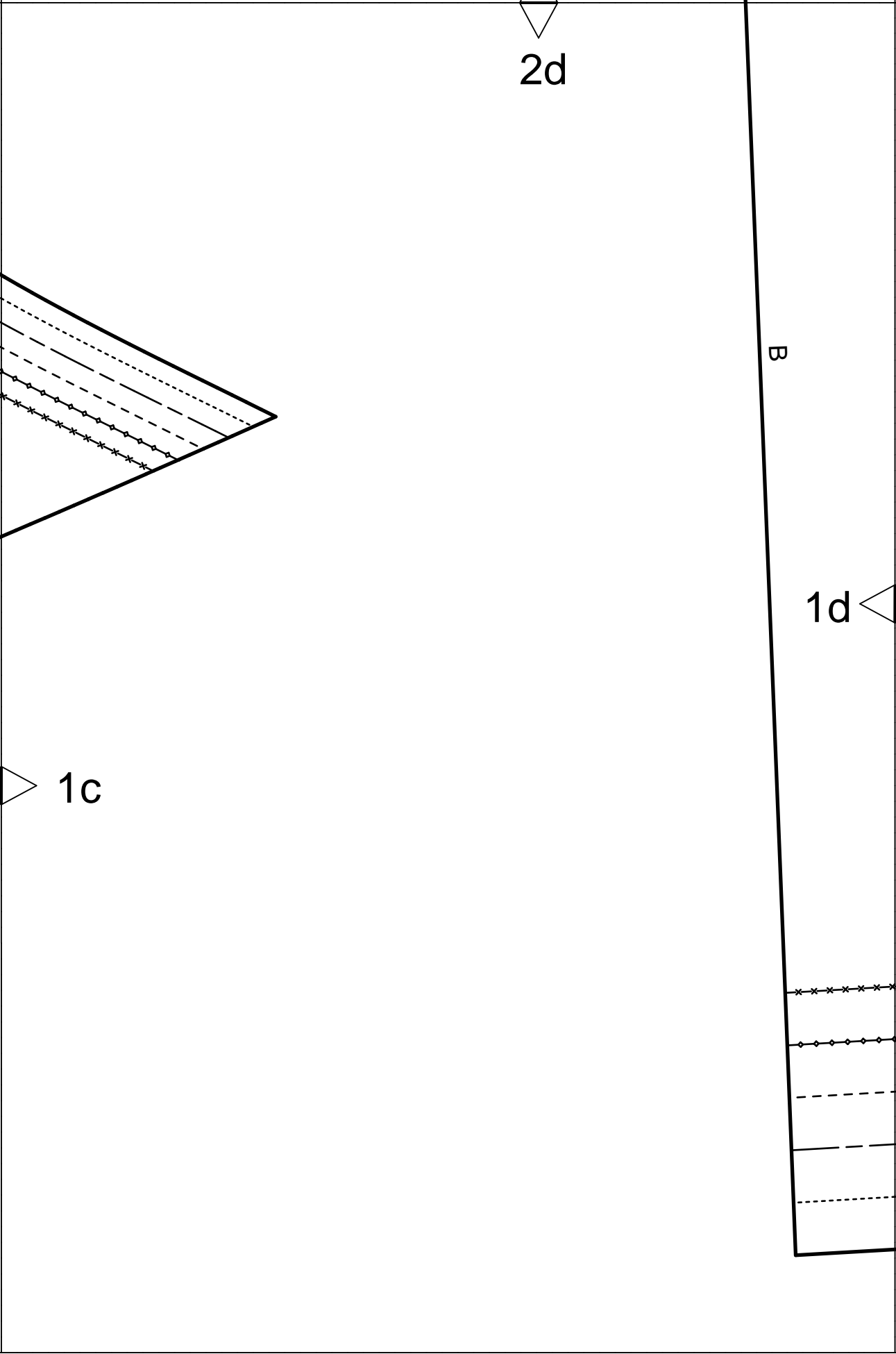

2e

1d

1e

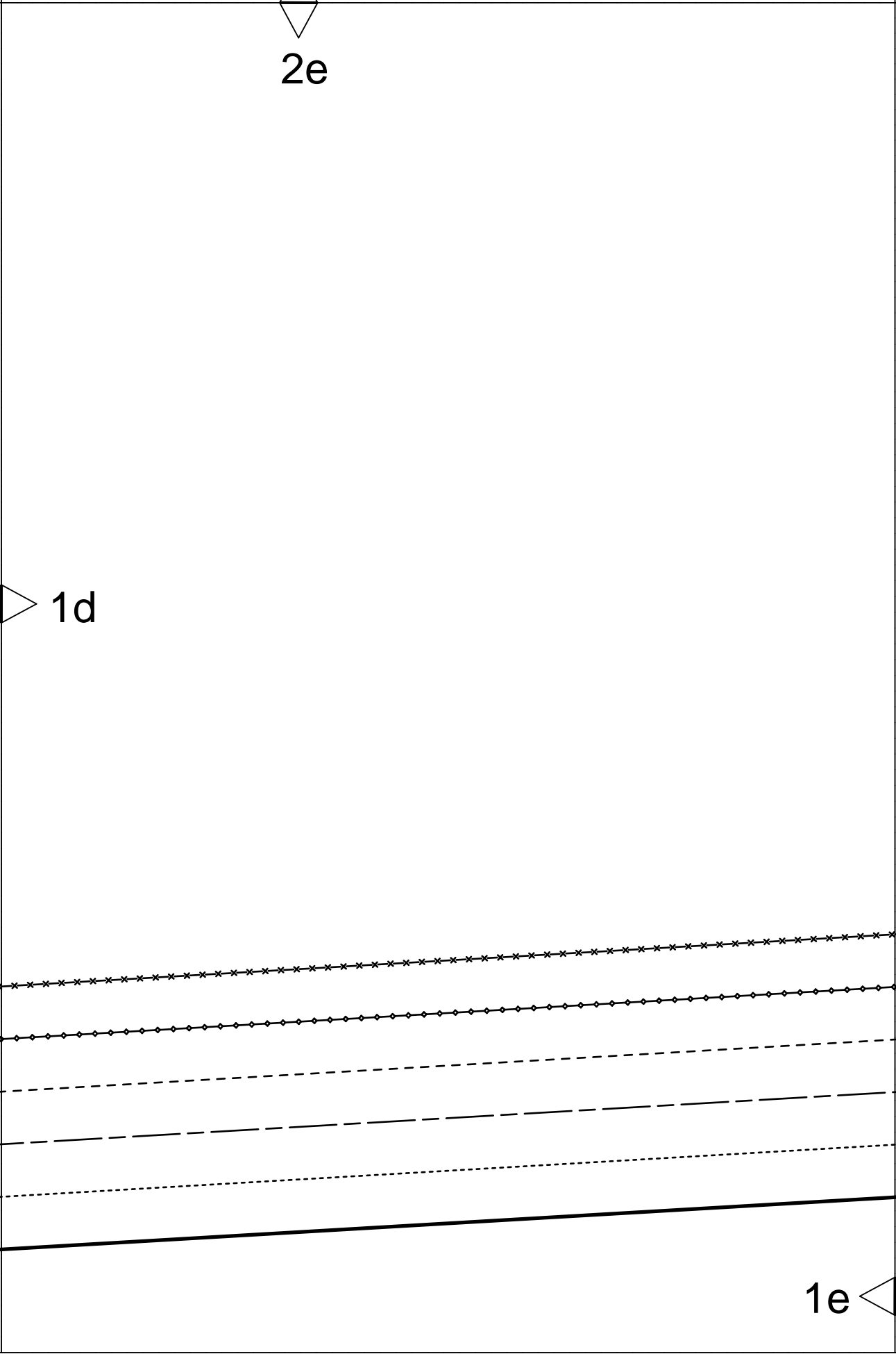

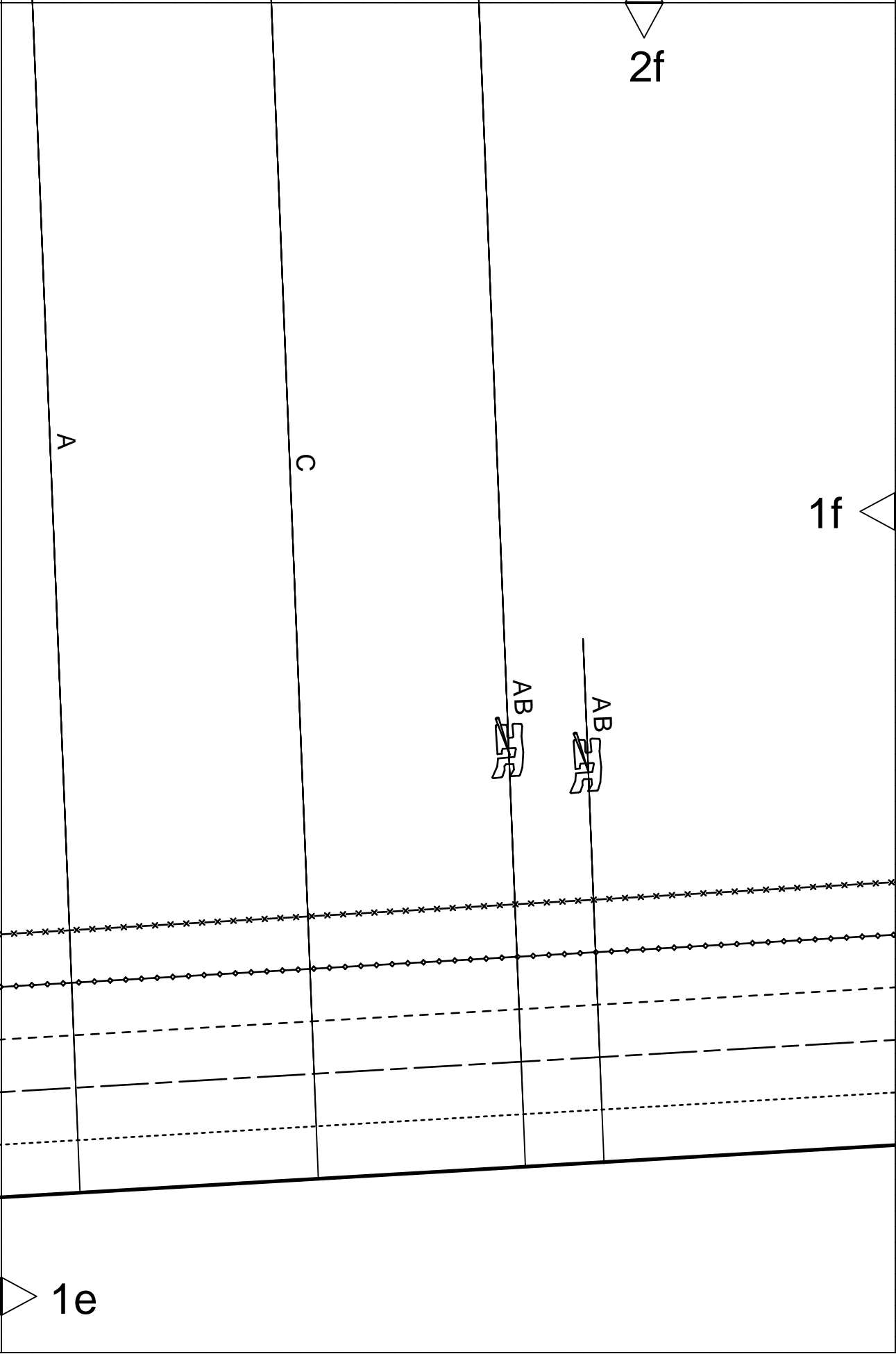

2g

1f

1g

2

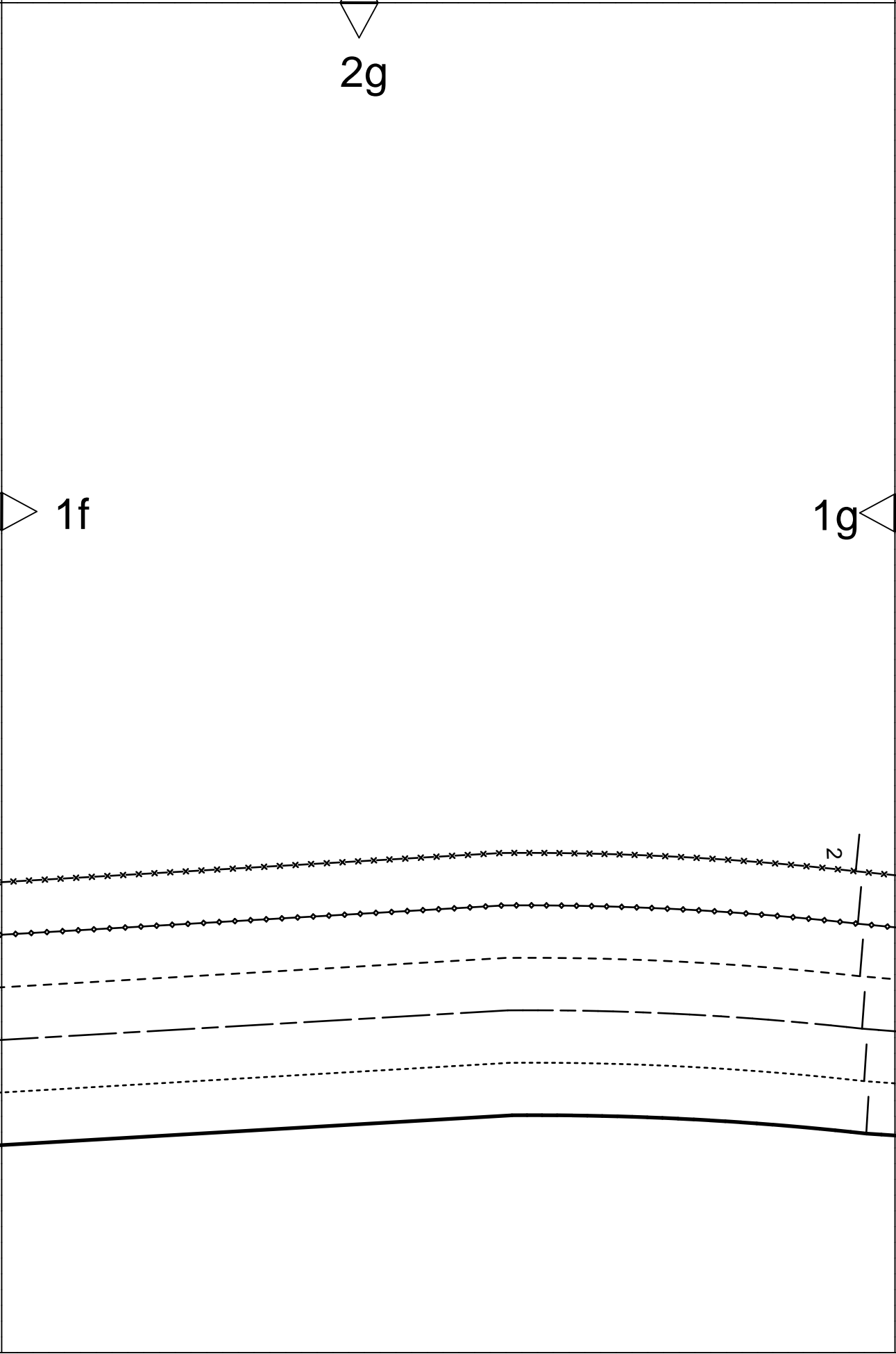

1h

2

Rückenteil
back
СПИНИКА
A, B, C

im Stoffbruch
on the fold
СТИБ ТКАНИ



Mod. 8

burda[®]
www.burdastyle.de

2h

1g

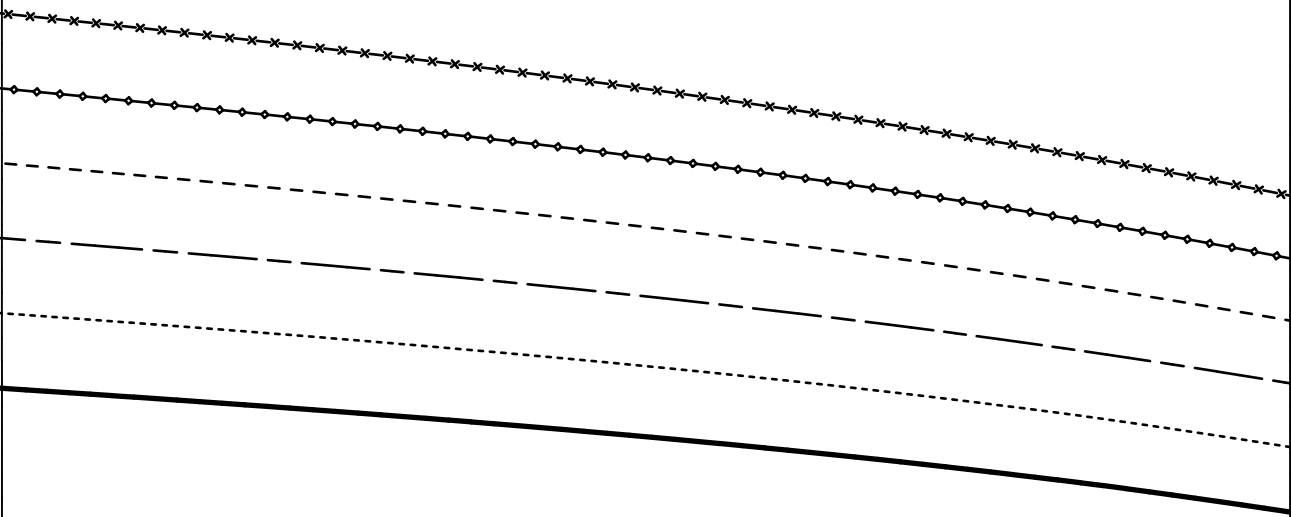

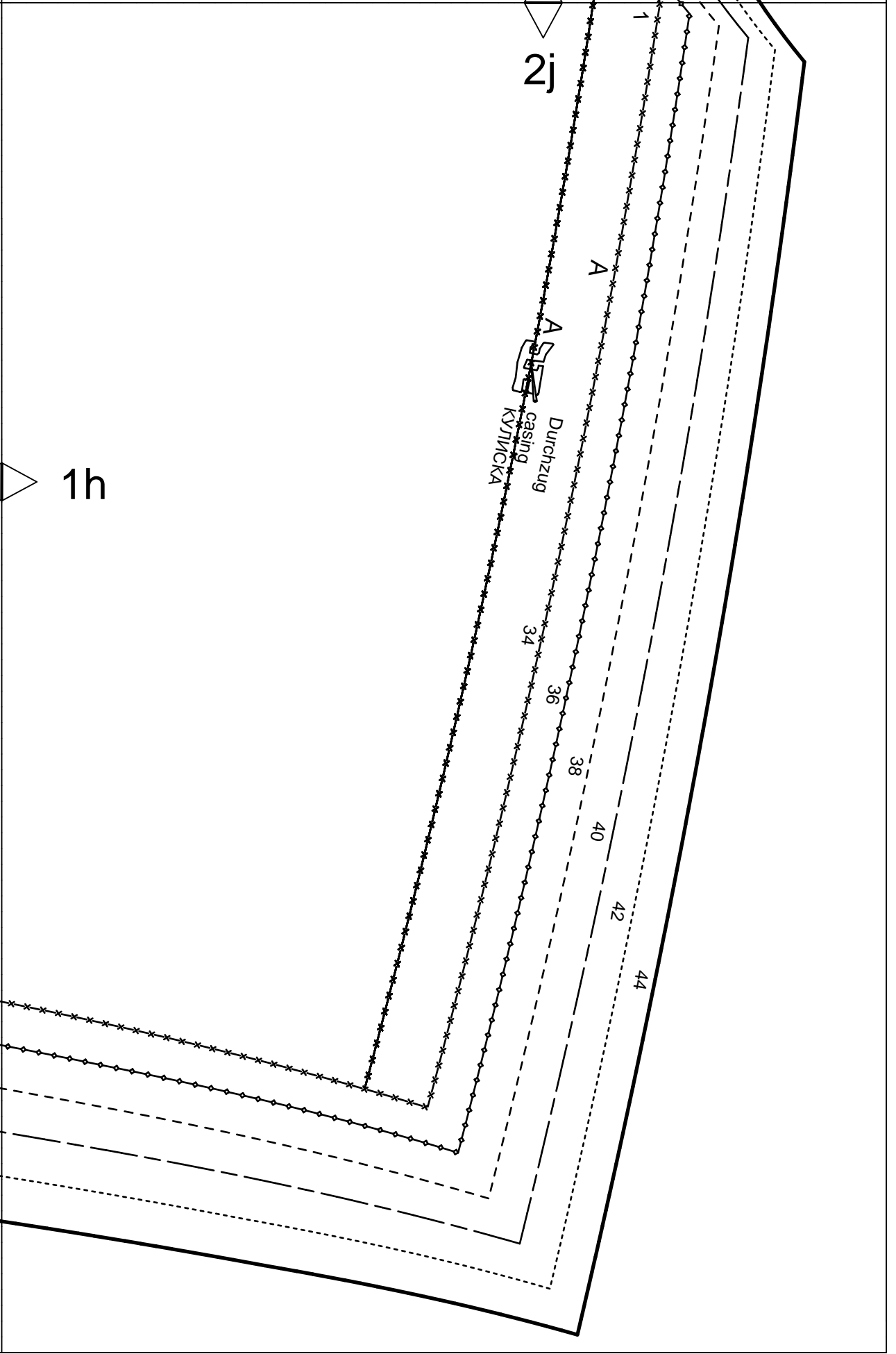

1h

2j

A
Durchzug casing
KYTIICKA

34
36
38
40
42
44

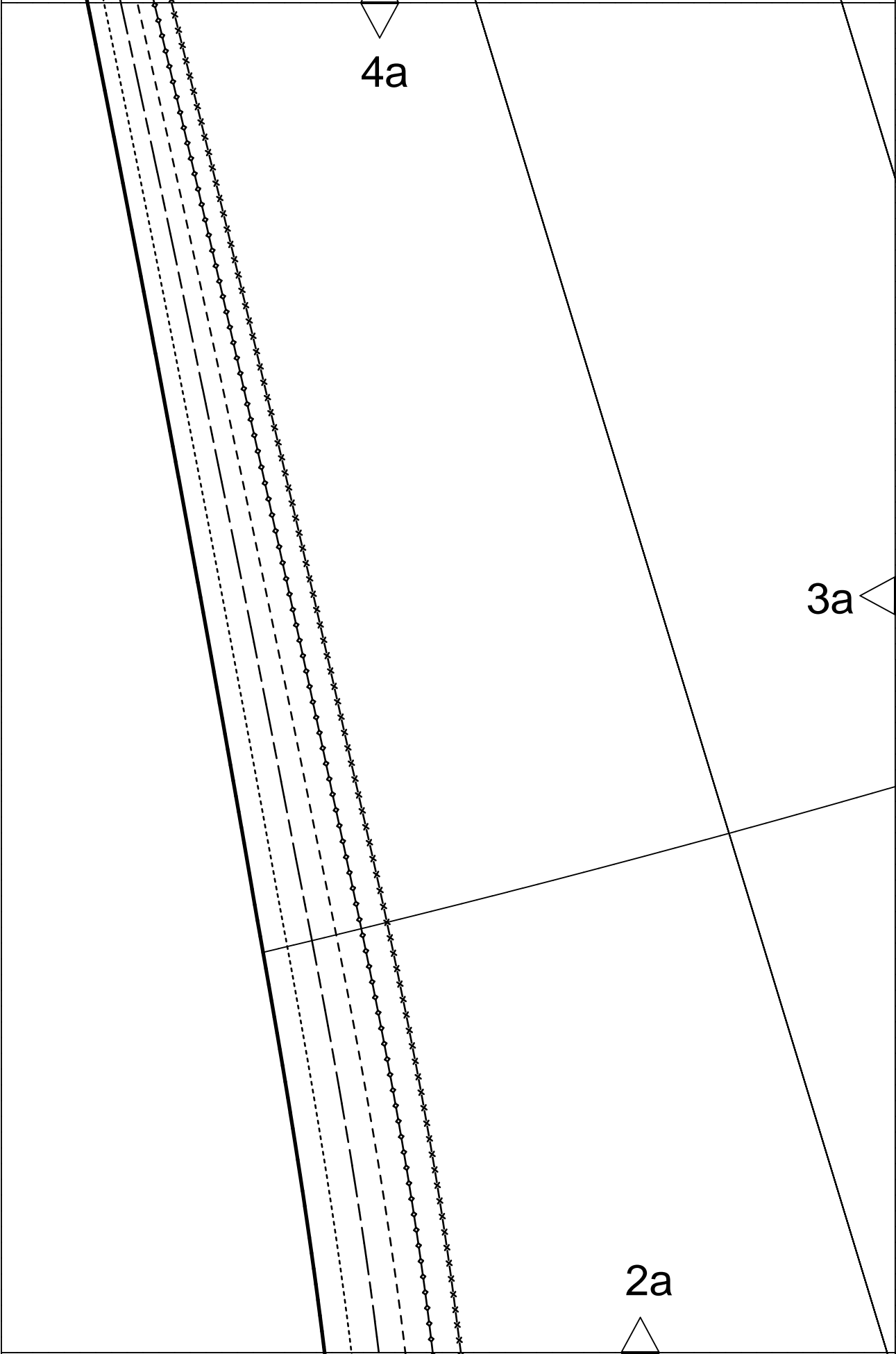

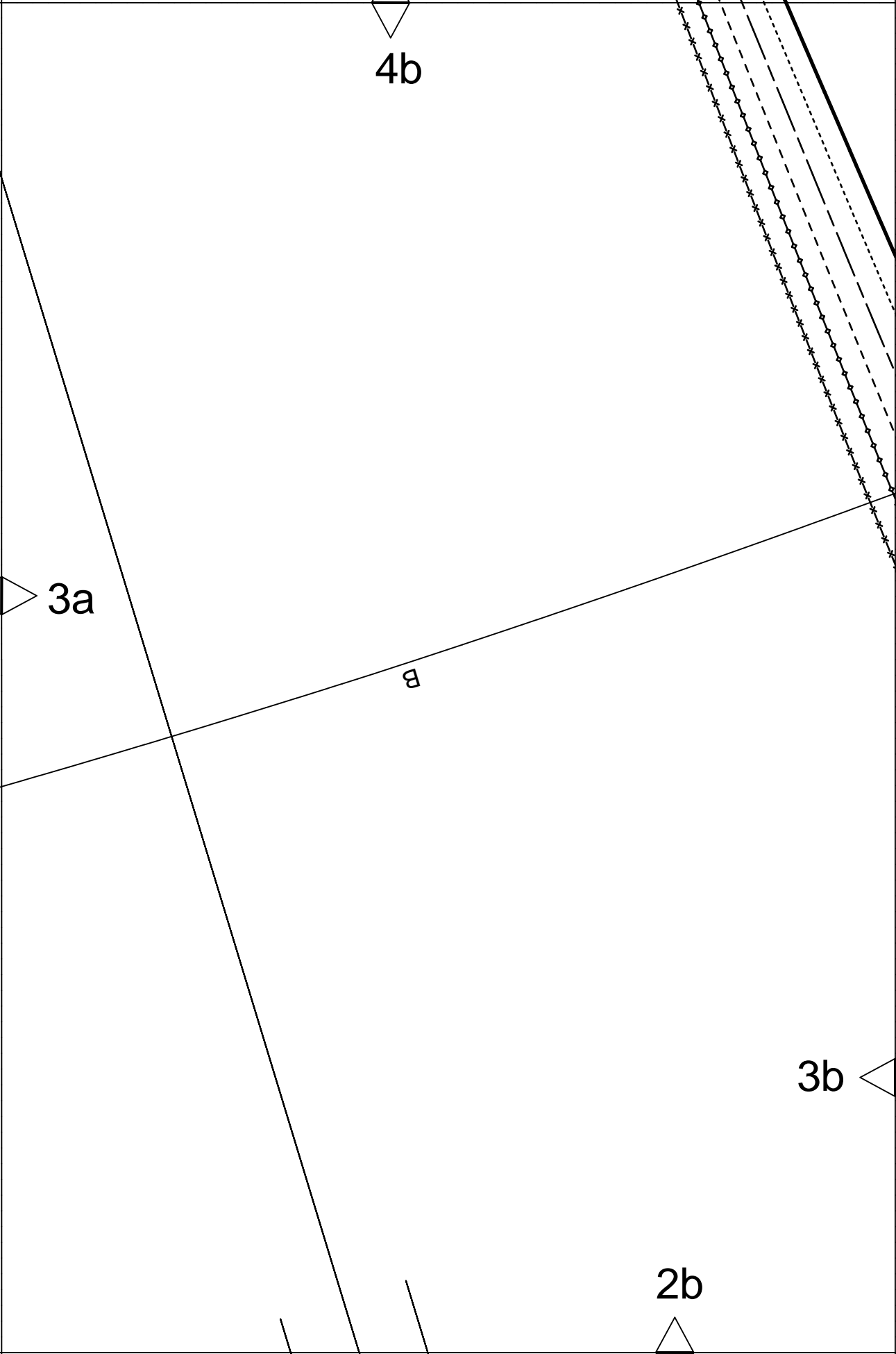

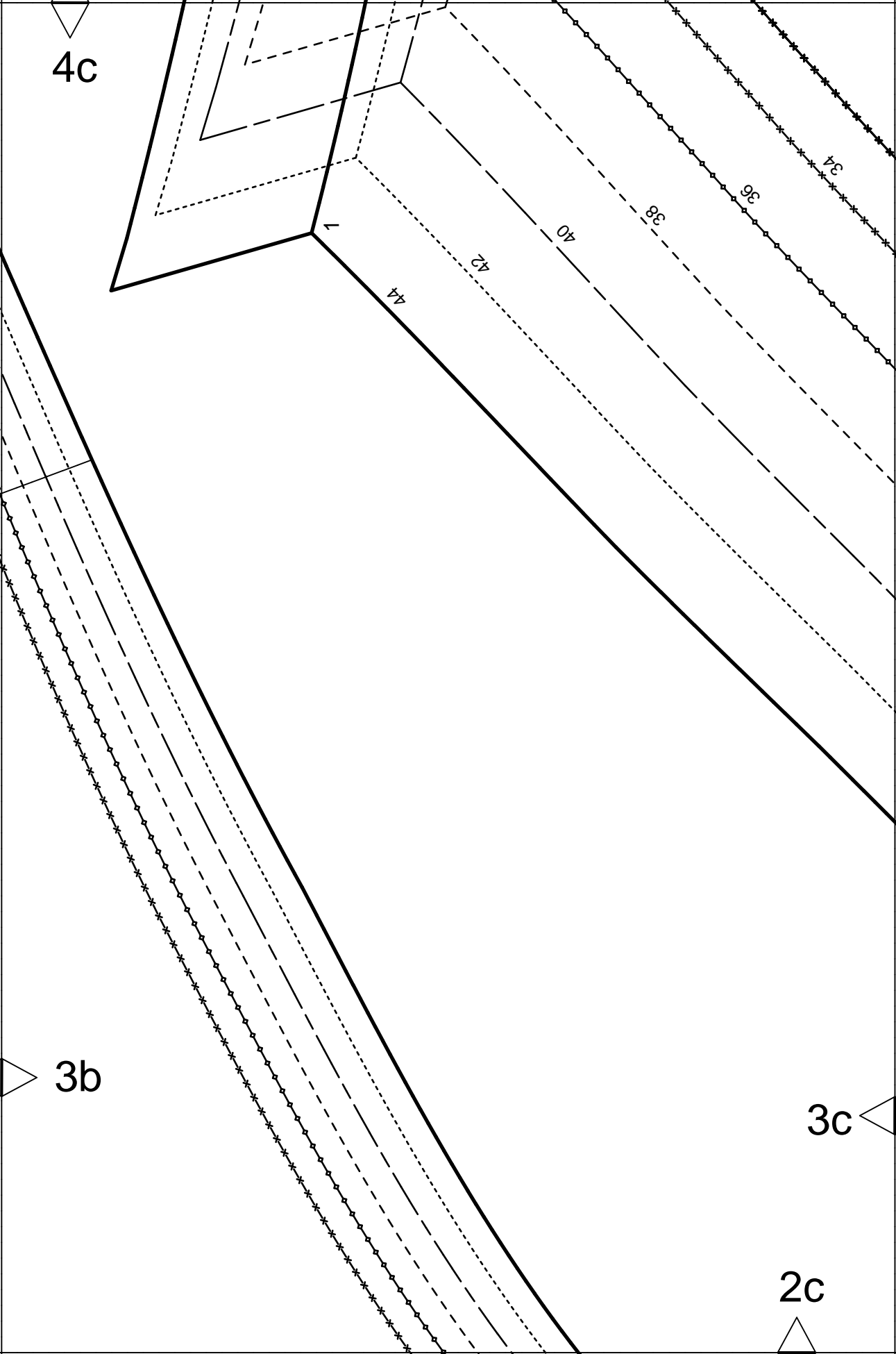

4c

34

36

38

40

42

44

3b

3c

2c

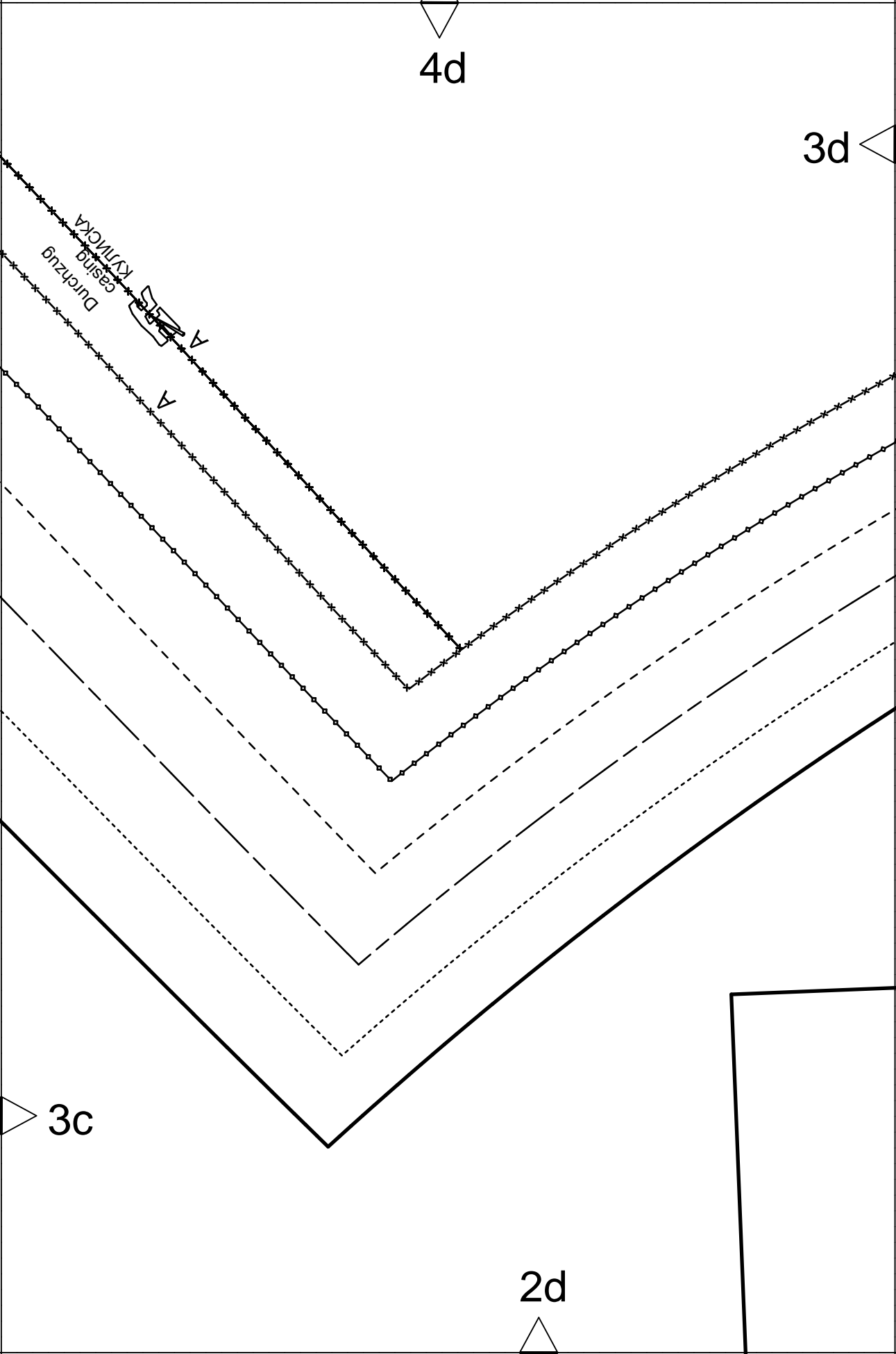

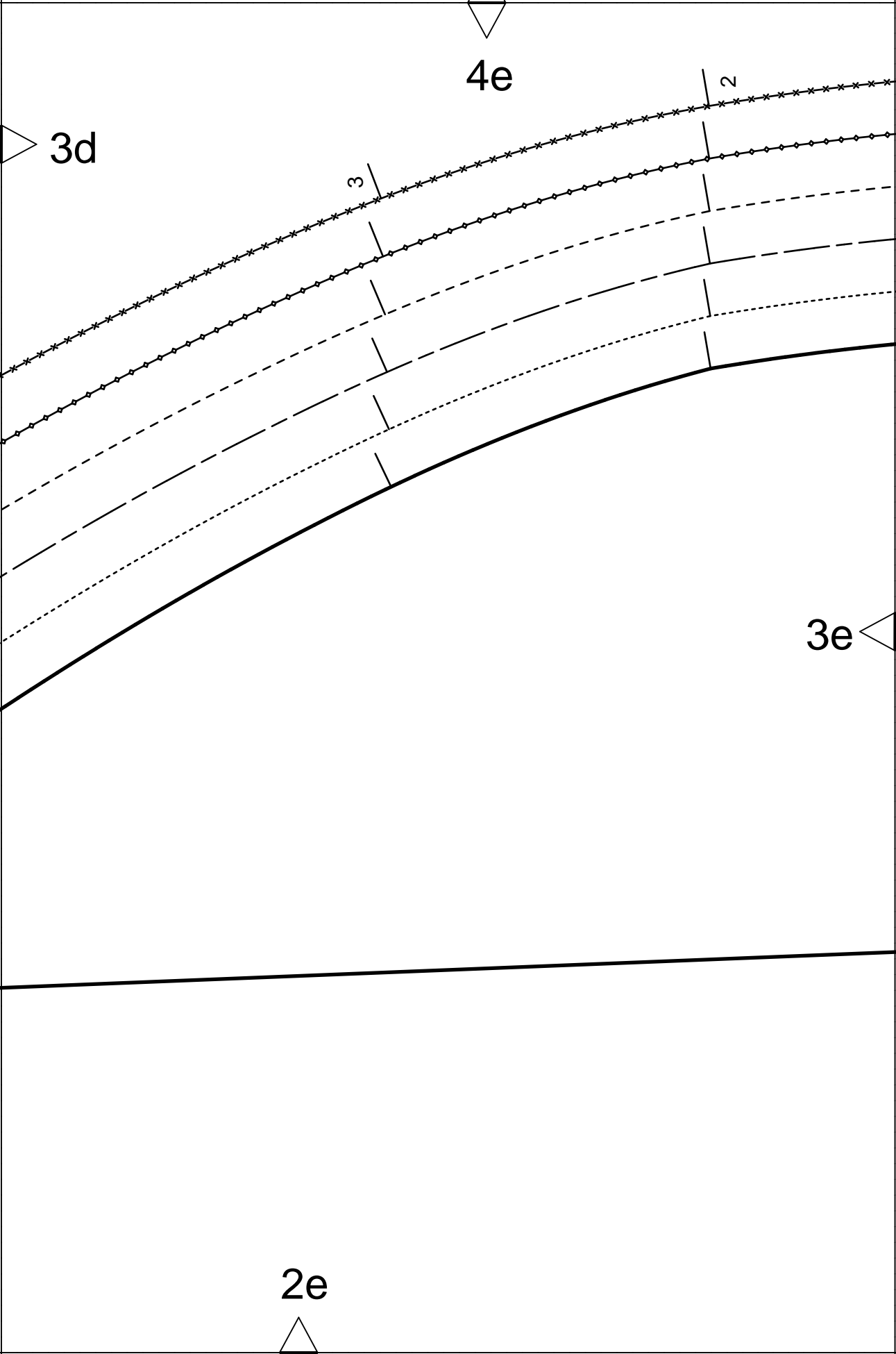

4f

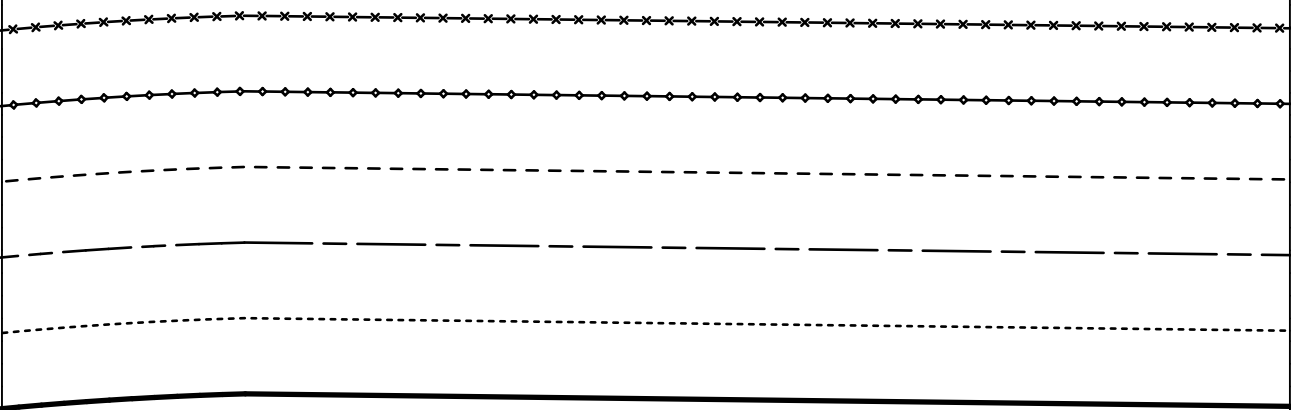

3e

3f

2f

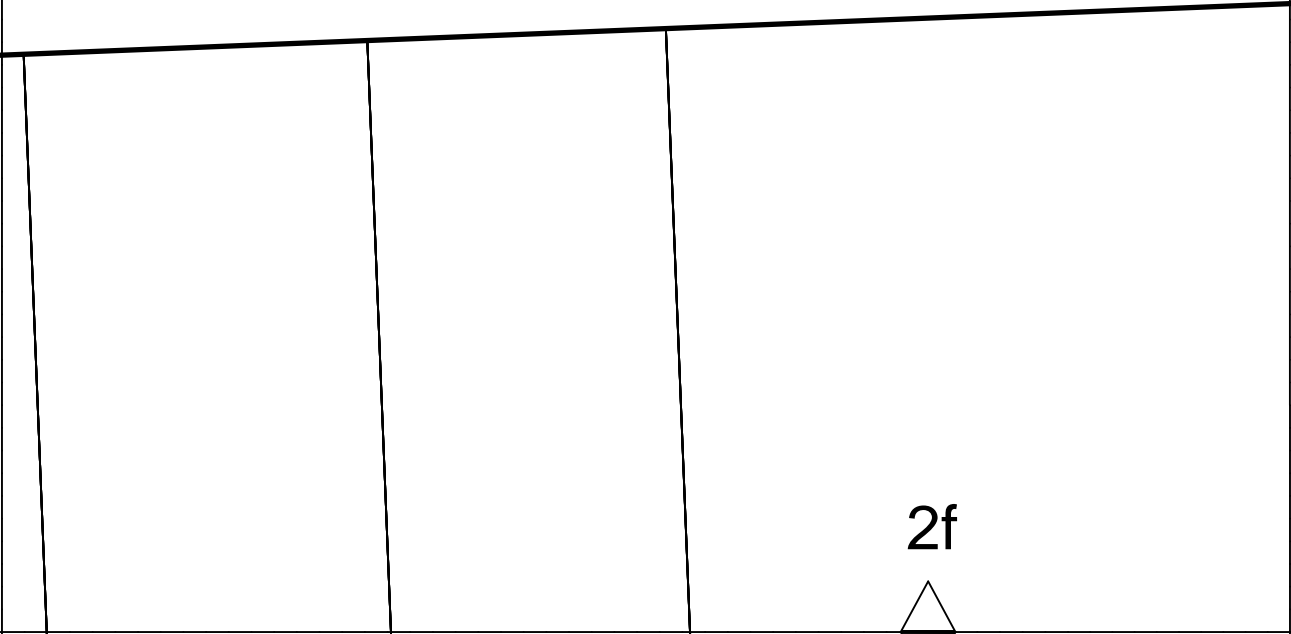

СШС
AB
СШС

4g

3f

3g

Taille
waist
ТАЛИЯ

2g

4h

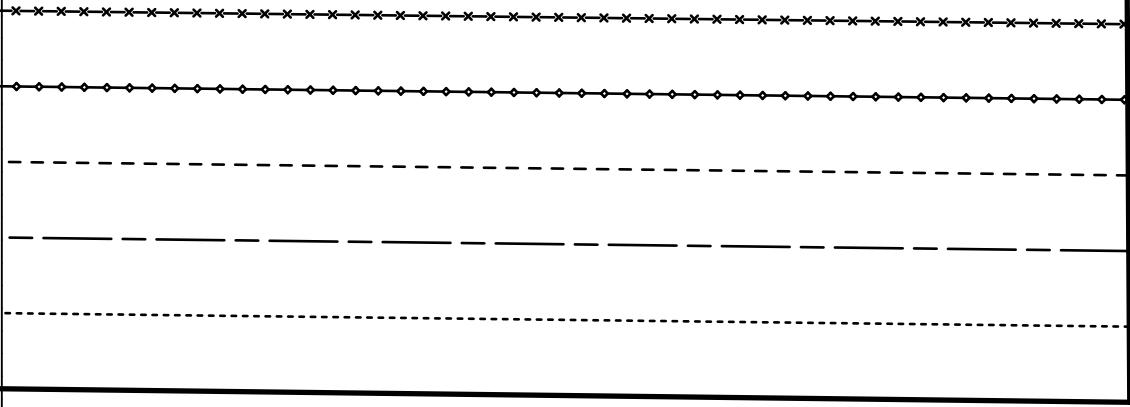

3h

3g

rückwärtige Mitte Stoffbruch Fadenlauf
center back fold straight grain
ЗАДНЯЯ СЕРЕДИНА СГИБ ДОЛЕВАЯ НИТЬ

2h

4j

3h

2j

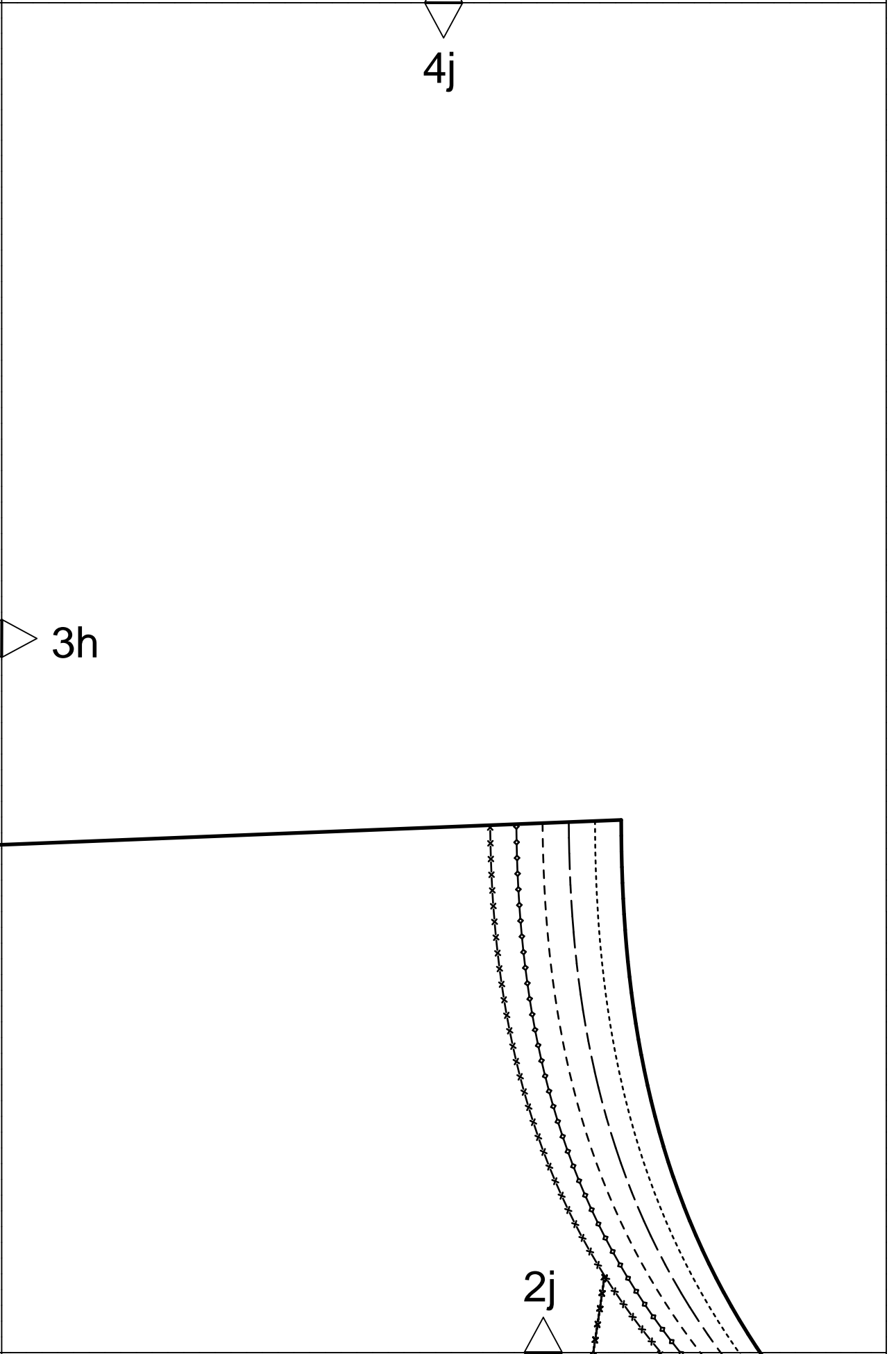

burda[®]
www.burdastyle.de

5a

3

4a

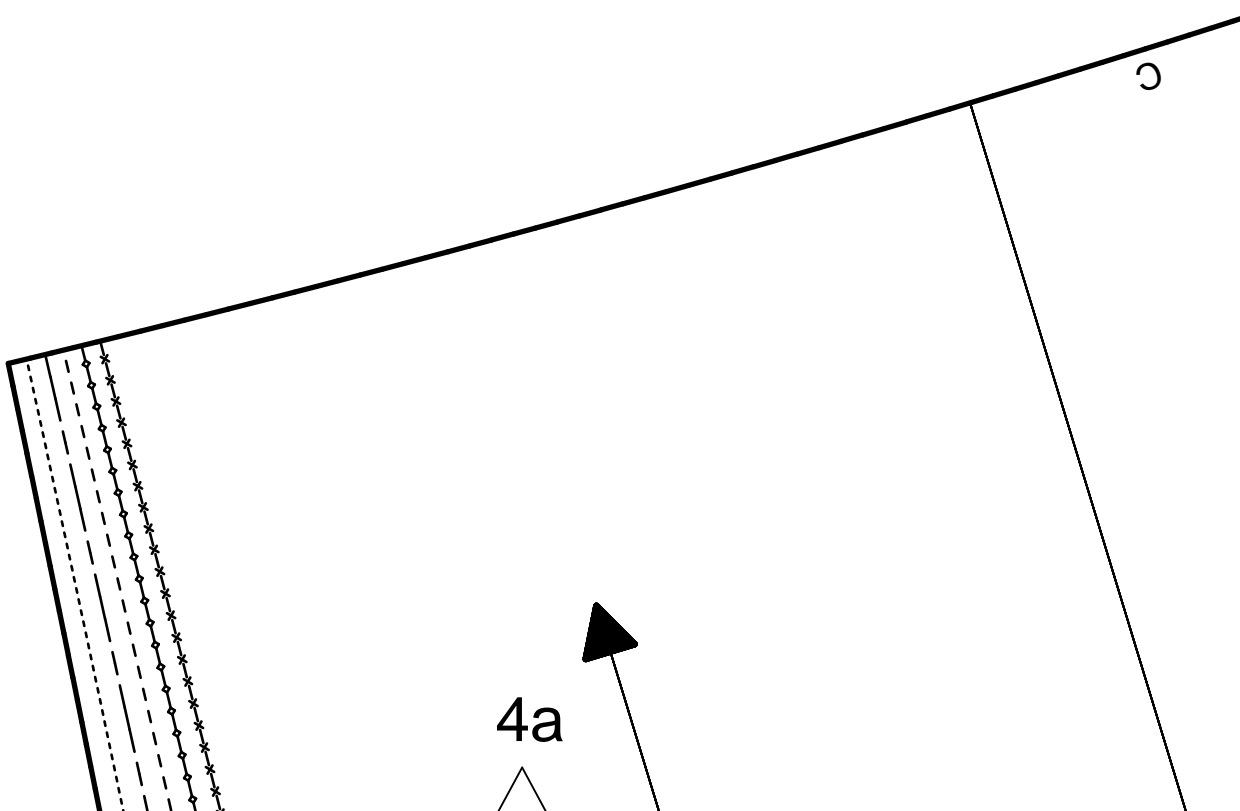

5a

5b

4b

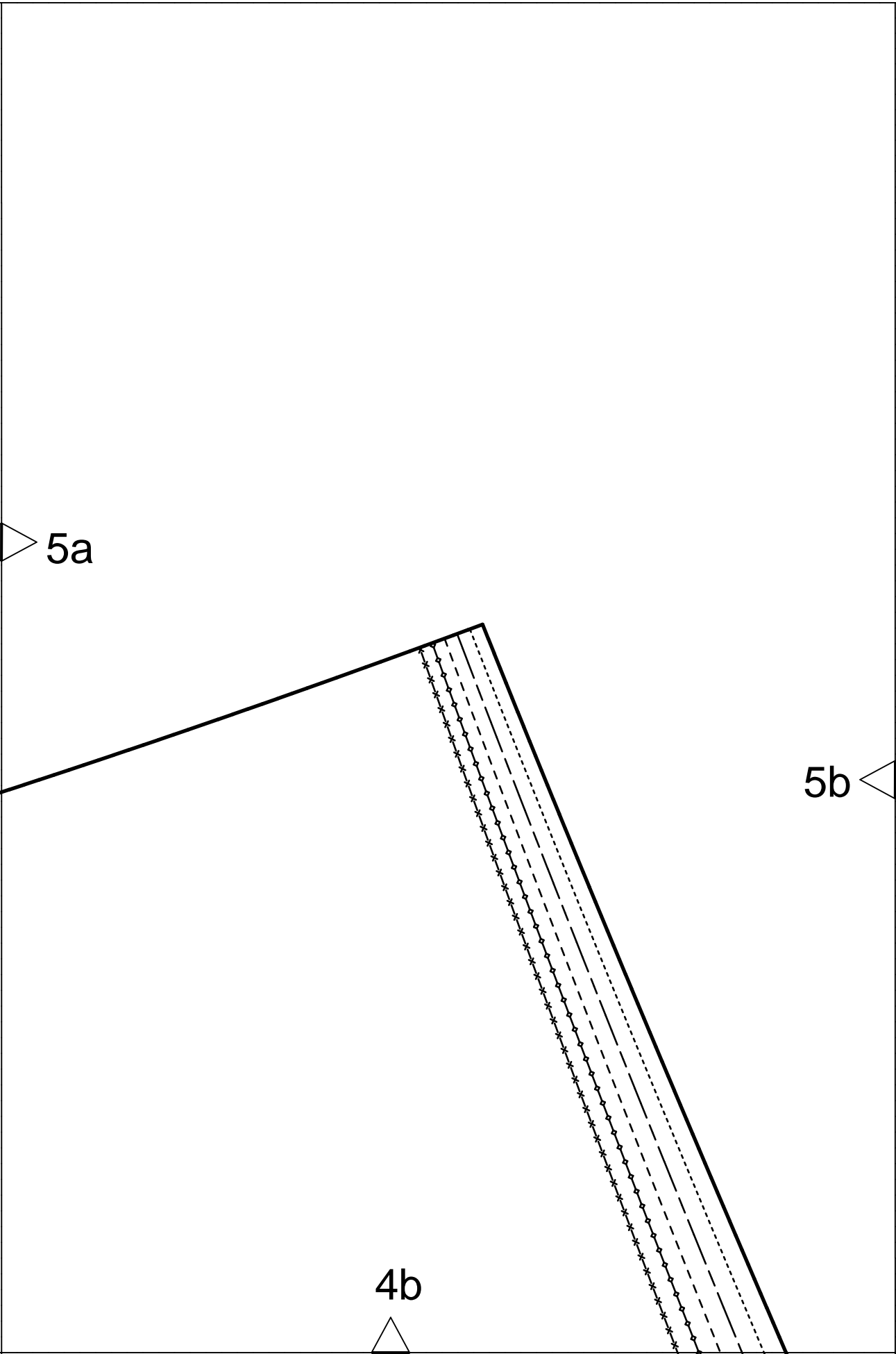

5b

5c

4c

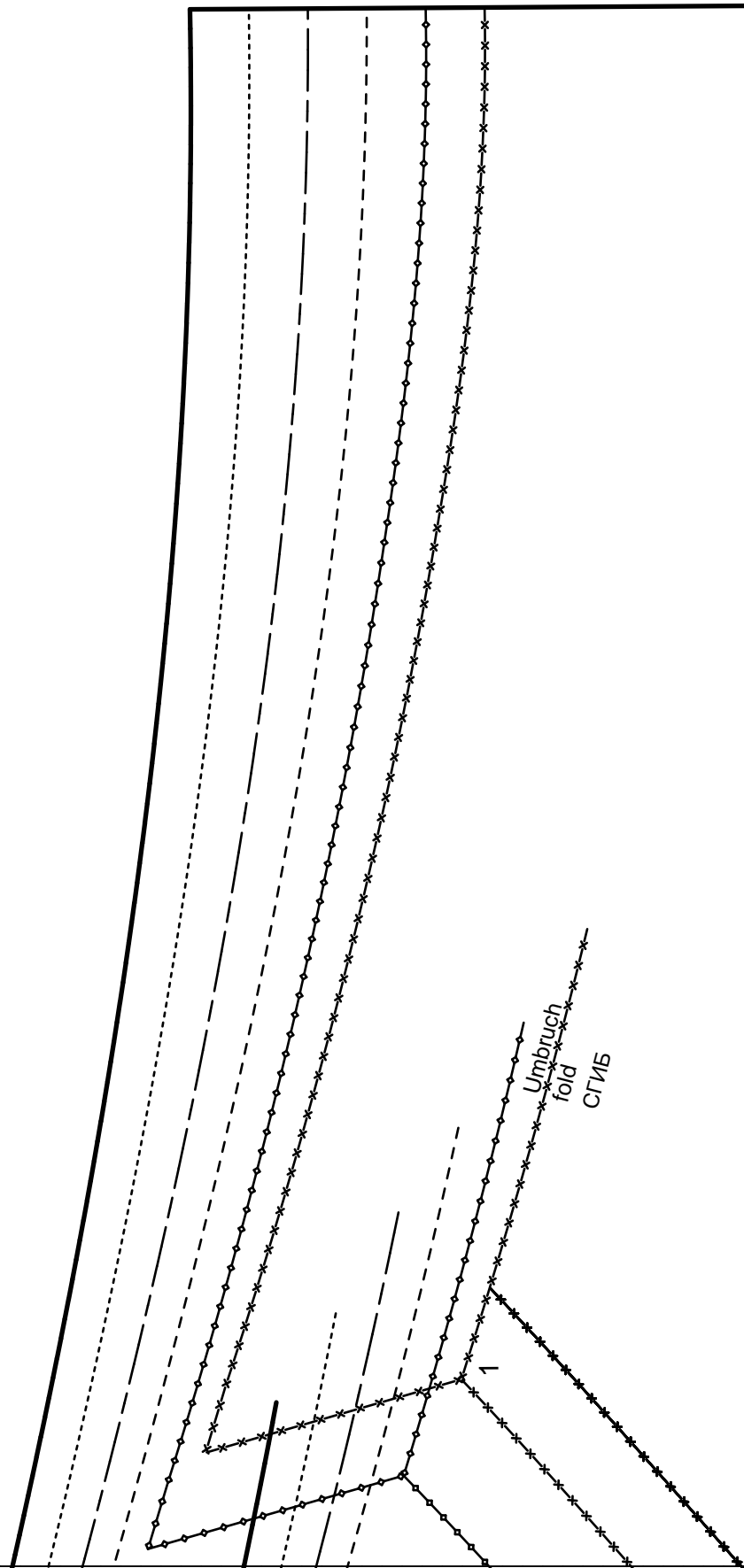

1

Vorderteil
front

ПЕРЕД, ПОЛОЧКА

A, B, C

 1X
im Stoffbruch
on the fold
СГИБ ТКАНИ

Mod. 8

burda[®]
www.burdastyle.de

4d



5c



5d



Линия середины передая часть долевая нить
center front fold straight grain
vordere Mitte Stoffbruch Fadenlauf

5d

5e

4e

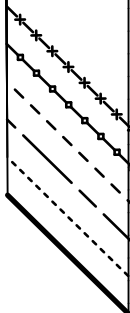

Taille
waist
ТАЛИЯ

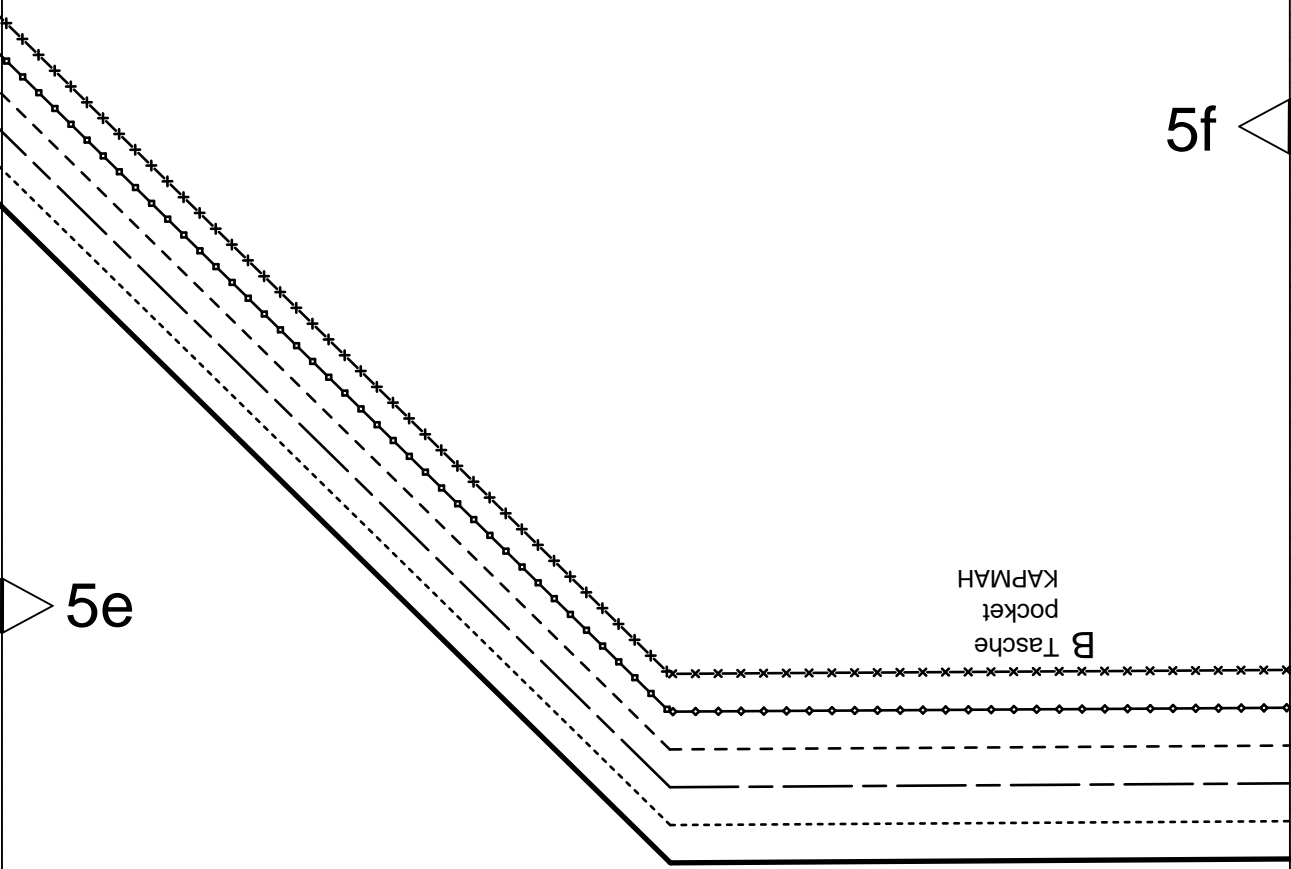

5e

5f

B
Tasche
pocket
карман

4f

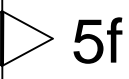

5f

C

A



5g

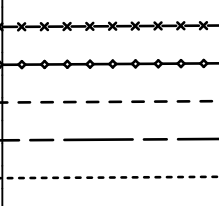

AB

Durchzug
casing
КУЛИСКА

4g



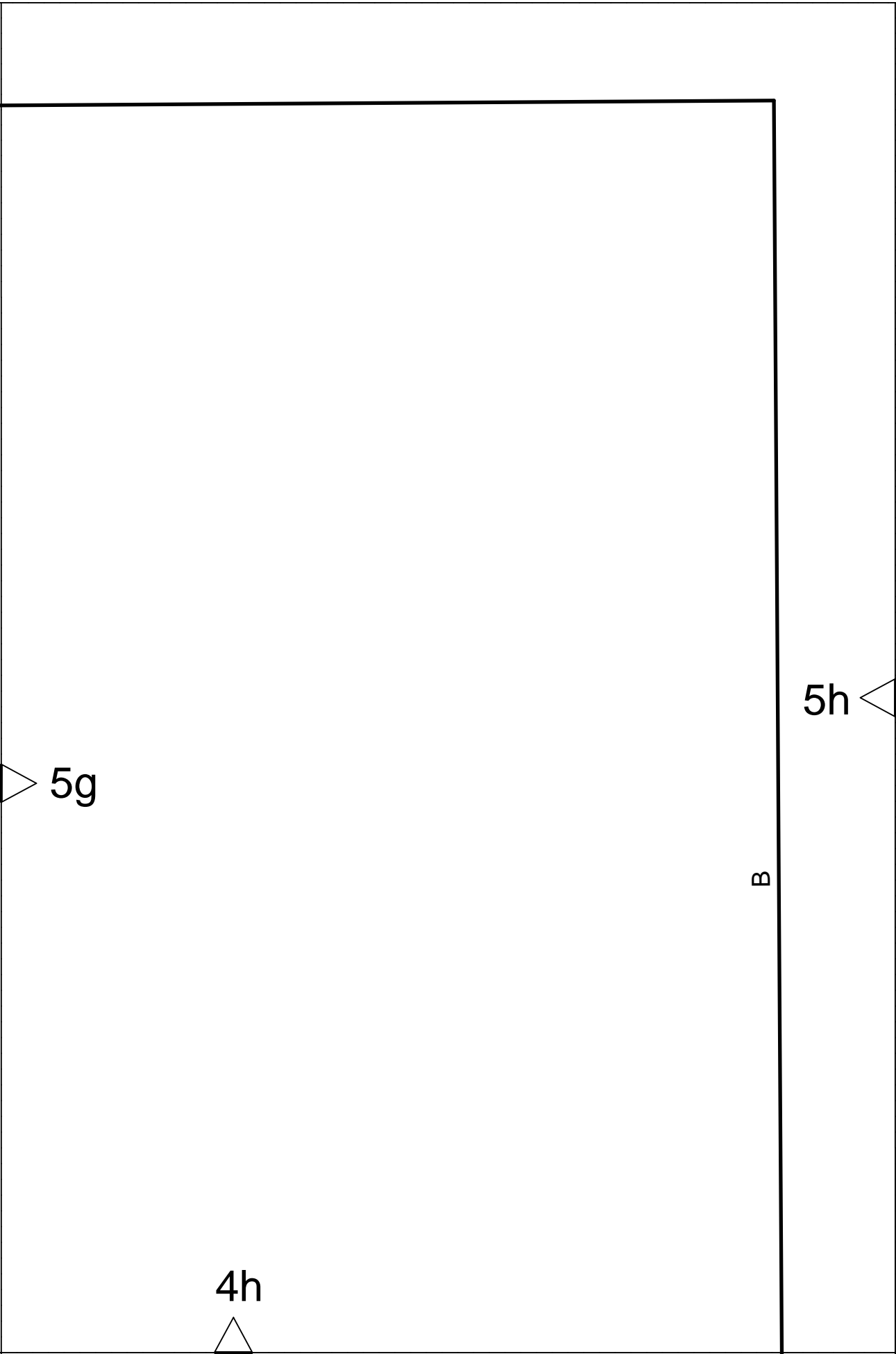



Kontrollquadrat / test square

Seitenlänge / side length
10 cm (4 inches)

5h

4j